

Data Sheet

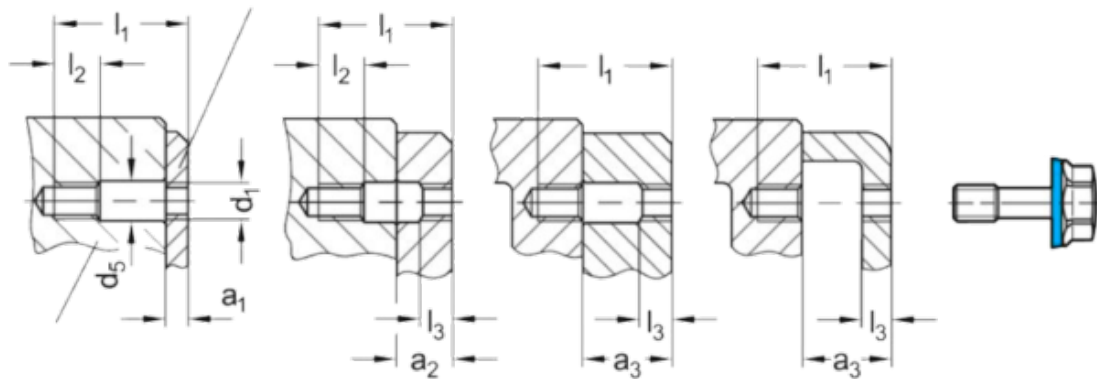

Article number: 201581M830MTE1
 Description: E+G Nut GN 1582-M8-30-MT-E-1
 Hygienic design

Measures

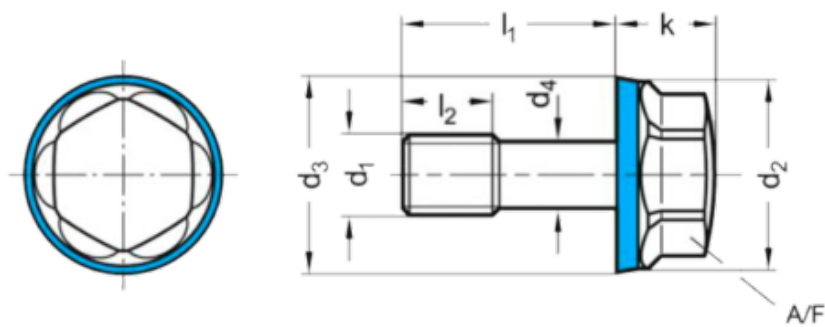

a1	= 4-8	l1	= 30
a2	= 8-16	l2	= 10
a3	= 16-20	l3	= 4
AF	= 13	Weight	= 18
d3	= 16.8		
d4 -0,2	= -		
d5	= 8.5		
k	= 8.5		